

Knauf sistemi pasivne zaštite od požara

Goran Stojilković, dia
rukovodilac tehnike suve gradnje



Gips je prirodan ne goriv materijal za zaštitu od požara



Gips sadrži približno 20% kristalizovane vode.

Gipskartonska ploča debljine 15 mm sadrži 3 litra vode po m²

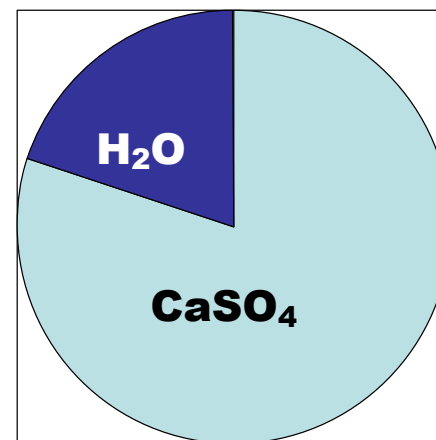



Knauf gips bez staklenih vlakana



Knauf gips sa staklenim vlaknima

Knauf ploče

Gipsana

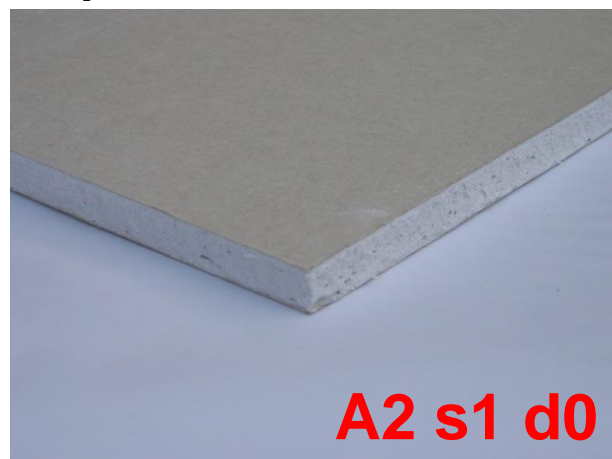

Vidiwall/vidifloor ploča

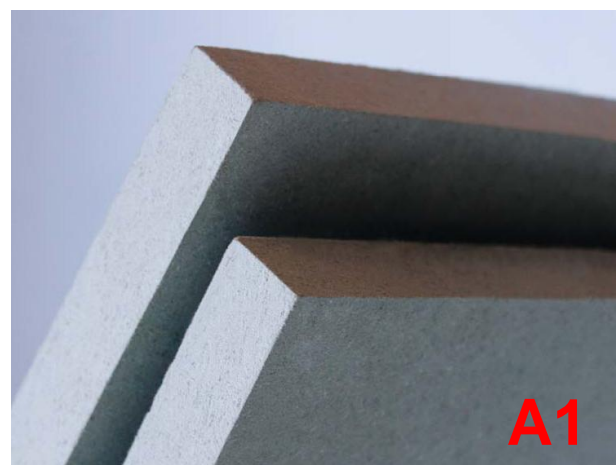

Fireboard

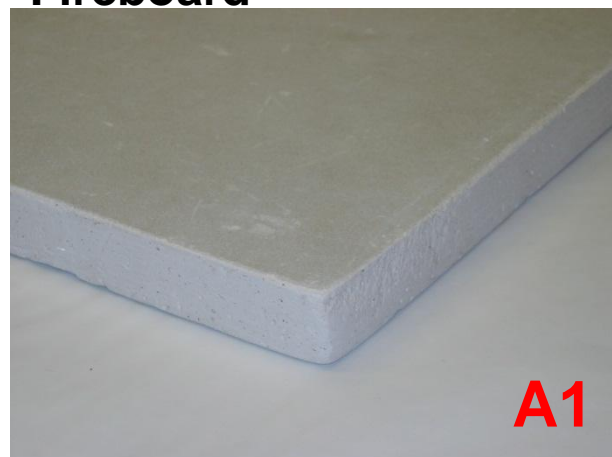

Aquapanel cementna ploča



Gips je prirodan materijal za zaštitu od požara



Prilikom zagrevanja voda postepeno isparava – velika količina toplote „troši” se na izdvajanje vode iz gipsa – površina gipskartonske ploče dugo zadržava maksimalnu temperaturu od 110° C

Gips je prirodan materijal za zaštitu od požara



Pukotine se javljaju usled
potpunog odsustva vode.
Ali i gips bez vode ne gori

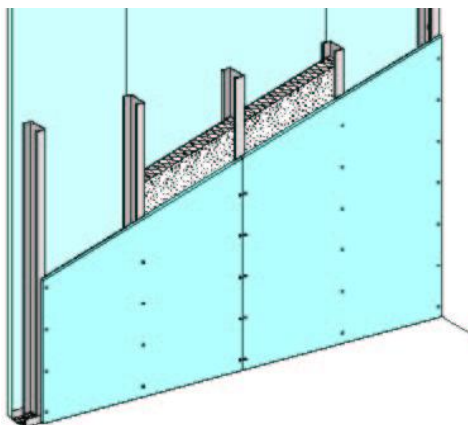

Pregrada W 111 → **F30 IMS**

obostrano jedan sloj

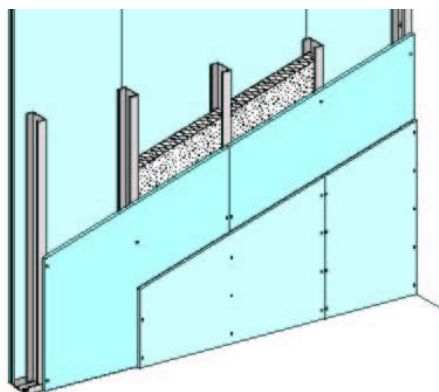

Pregrada W 112 → **F 90 IMS do F120**

obostrano dva sloja

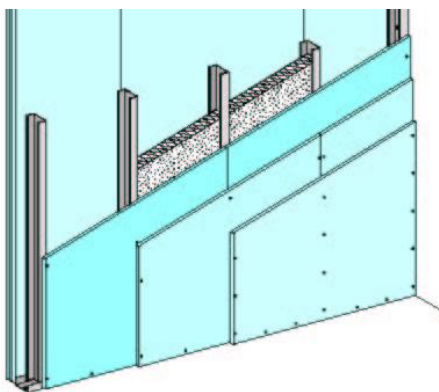

Pregrada W 113 → **F 120 IMS i F180**

obostrano tri sloja



Bioskopski zid Diva W145 - F180 – Colosej

Izveštaj o ispitivanju zida DIVA - W 145 za F 180

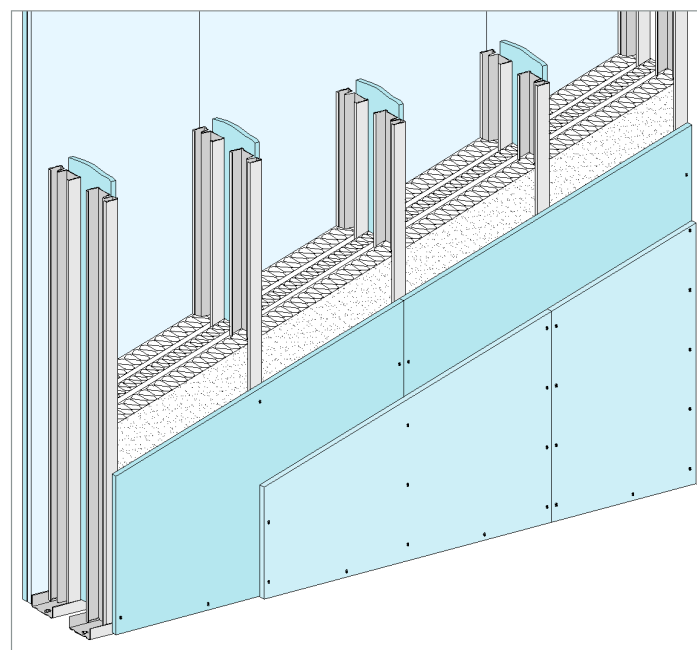
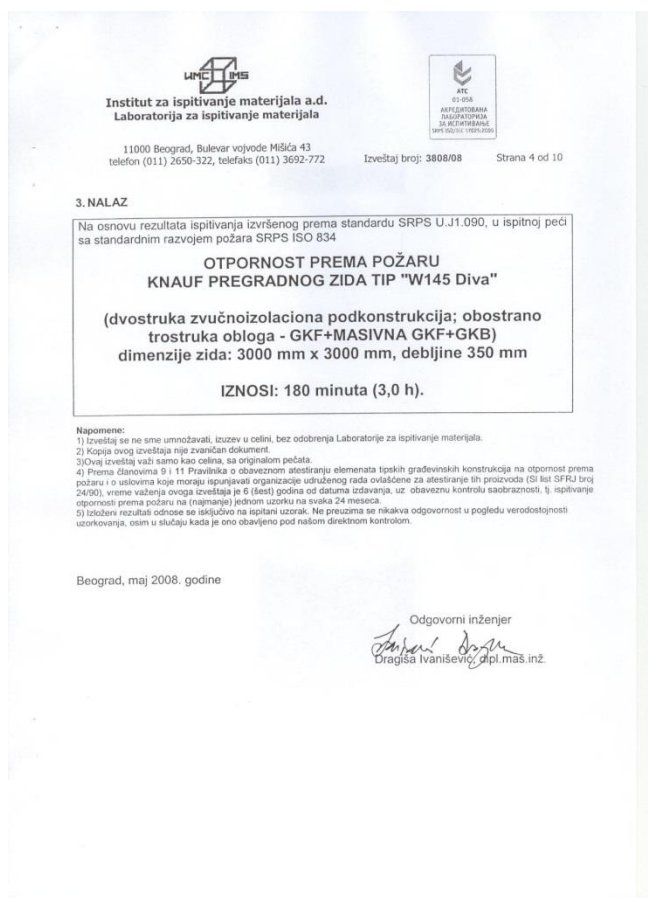

W145-P1

Perspektive Schallschutzwand

Aquapanel fasadni zid - IMS F90

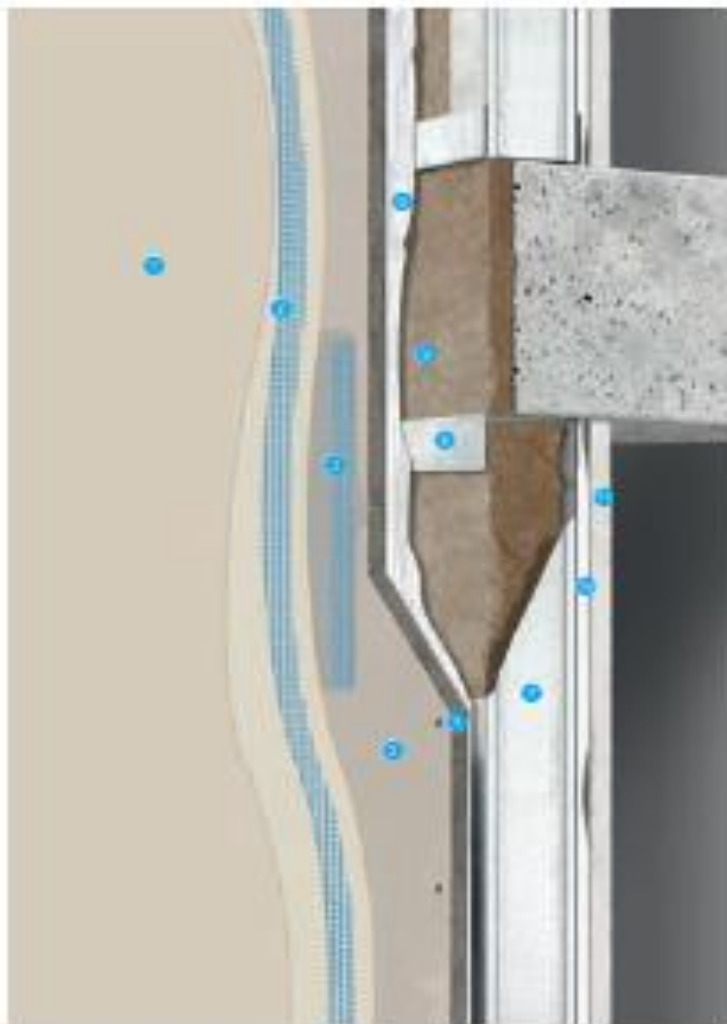

Šaht obloge – instalacioni kanali

Protipožarne pregrade za šahte / vertikalni kanali za instalacione vodove

Pregrada W 628 A

F90

Š ≤ 2,00 m

V ≤ ∞ m

Maksimalna dopuštena visina nije ograničena

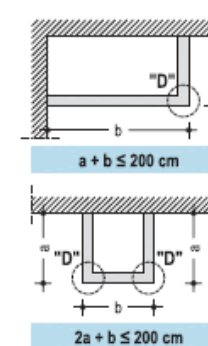
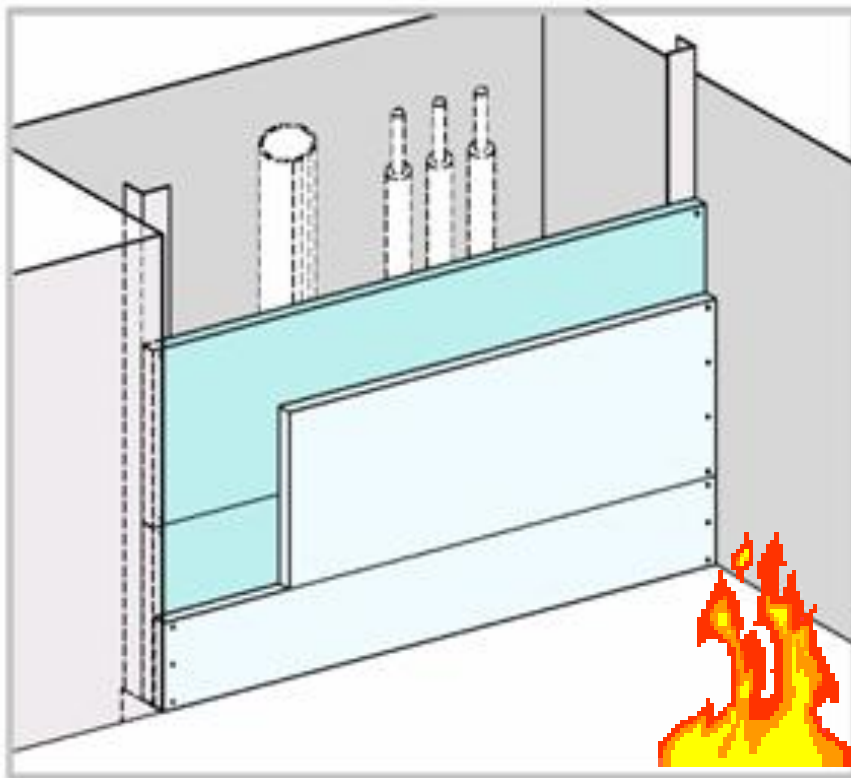

Šaht obloge – instalacioni kanali

Protipožarne pregrade za šahte / vertikalni kanali za instalacione vodove

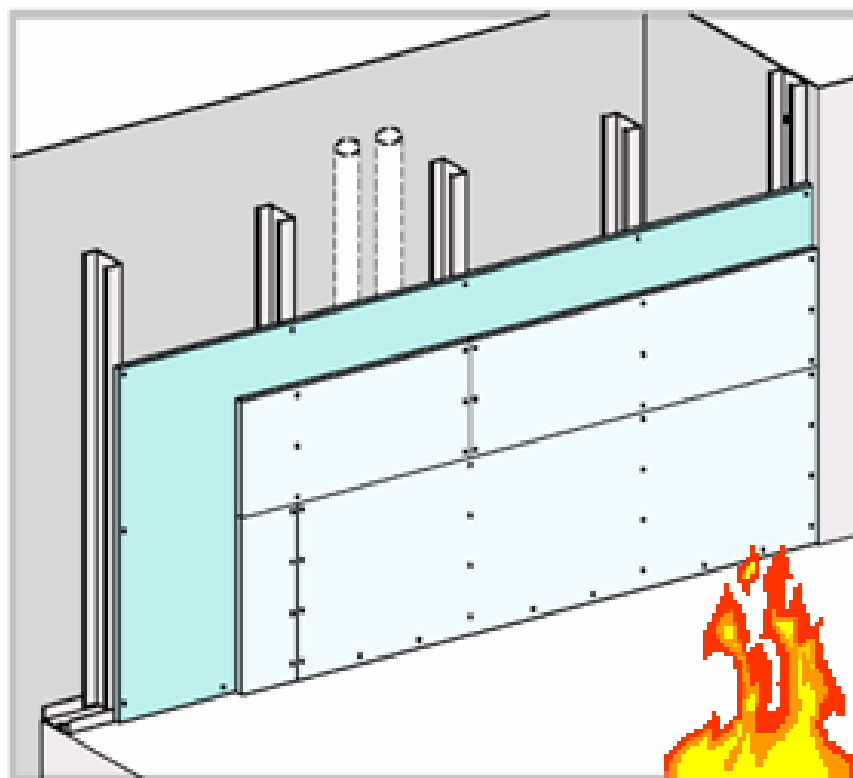

Pregrada W 628 B

F30-F90

Š ≤ ∞ **m**

V ≤ **5,00 m**

Maksimalna dopuštena visina je
Ograničena na 5 metara

Šaht obloge – instalacioni kanali

Protipožarne pregrade za šahte / vertikalni kanali za instalacione vodove

Pregrada W 629

F30 - F 120

Š ≤ ∞ **m**

V ≤ **8,50 m**

Maksimalna dozvoljena visina je ograničena na 8,5 metara

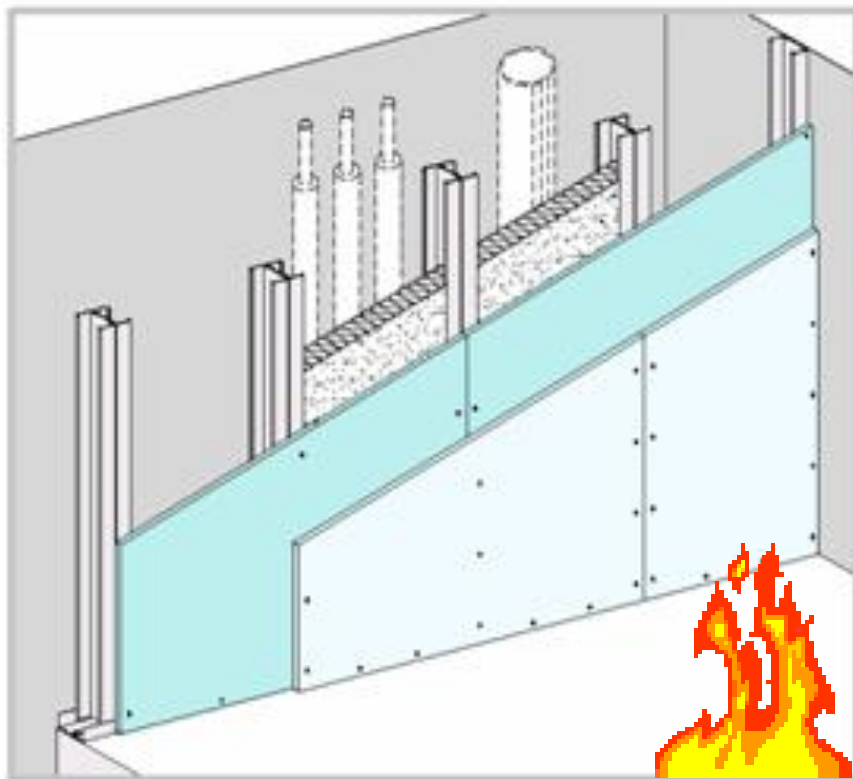

Šaht obloge – instalacioni kanali

Protipožarne pregrade za šahte / vertikalni kanali za instalacione vodove

Pregrada za šahte W 629

- Požar - debljina obloge
 - Vidiwall** ploča + kam,vuna 50 mm:
 - E120/EI 60/EW 120 1x12,5 mm = F60**
 - E120/EI 90/EW 120 = 2x12,5 mm = F90**
- razmaci profila: maks. 62,5 cm
- 2 spojena CW 100 profila

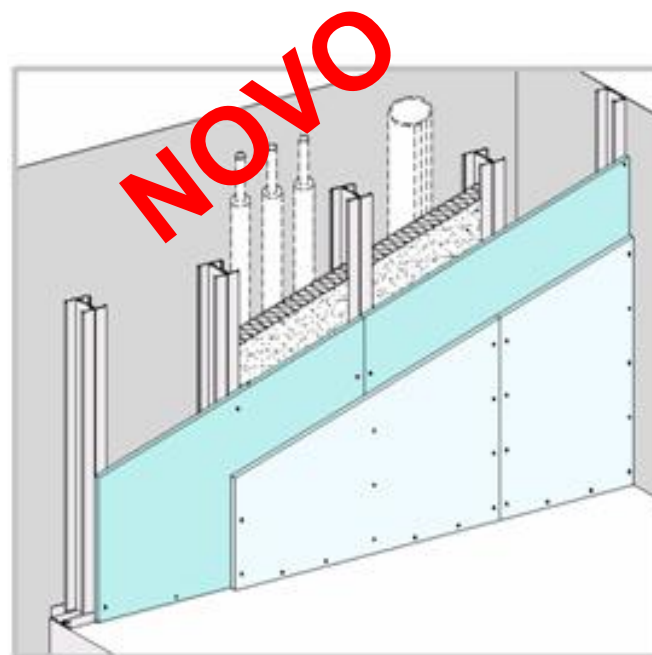

Primena: Protivpožarna pregrada za šahte – obostrana zaštita od vatre
LIFTOVSKA OKNA

PP Revizioni otvori – vezani su za sistem



- ▶ **D131 i K219 samonoseći plafoni**



- ▶ **Spušteni plafoni F30 do F90:
D112, D113, D116, ...**



- ▶ **Zaštita od požara zidova F30 do F120
W111, W112, W113,samostojećih zidnih i šaht
obloga W62**

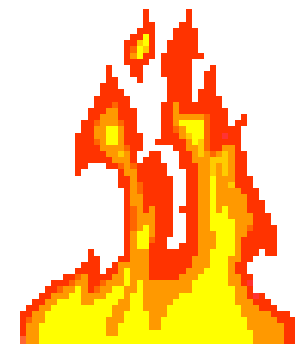

Obloga čeličnih stubova i greda Fireboard pločama



Bez potkonstrukcije – spajanje klemovanjem

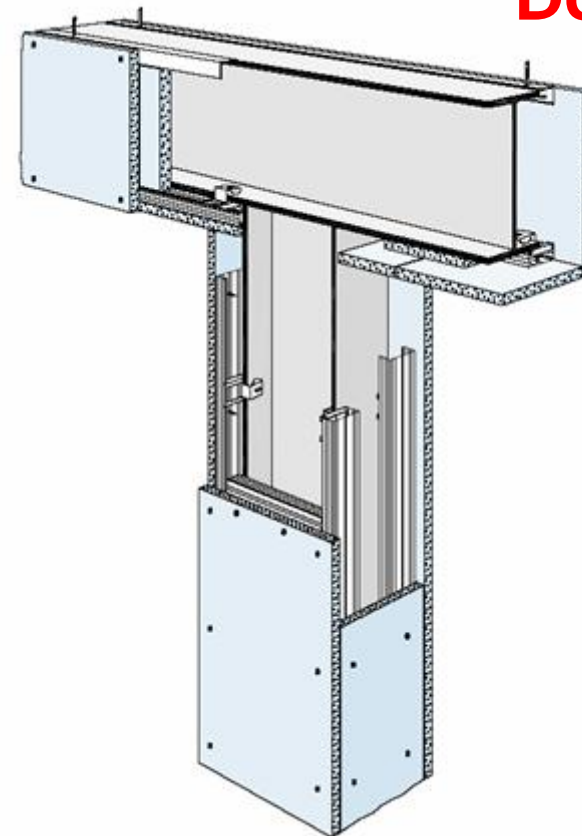

Do F180

CD potkonstrukcija – spajanje vijcima

Obloda drvenih stubova i greda Fireboard pločama

Do F90

Četverostrano oblaganje stupa



Trostrano oblaganje grede

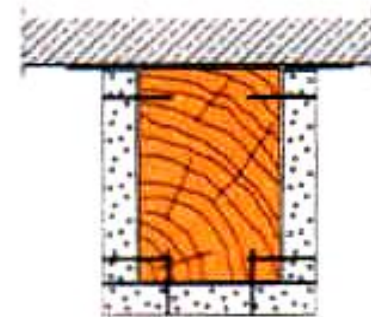

Protivpožarni spuštteni plafoni D11

samo odozdo

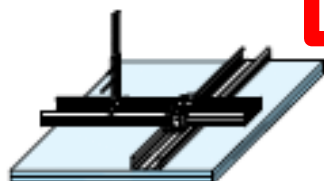

F30

F60

F90

	20	625	
	2x 12,5	500	
Požarnootporne ploče GKF, A2	18 + 15	500	
	2x 20	500	
	25 + 18		

obostrano

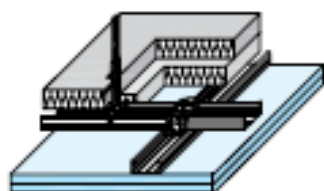

		F30
F30	F30	
F60	F60	
F90	F90	

	15	500	mineralna vuna 40 (60) 40 (30)	S
	18	625	+ mineralna vuna 40 (60) 40 (30)	S
Požarnootporne ploče GKF, A2	2x 12,5	500	150 mm širine na nosećim profilima	
	18 + 15	500		
	2x 20	500	mineralna vuna 2x 40 (60) 40 (30)	S
	25 + 18			

Protivpožarni plafoni od Fireboard ploča

Požarna zaštita odozdo za trapezaste limove / sistem K218

F120 Knauf FIREBOARD ploče 2 x 25 mm

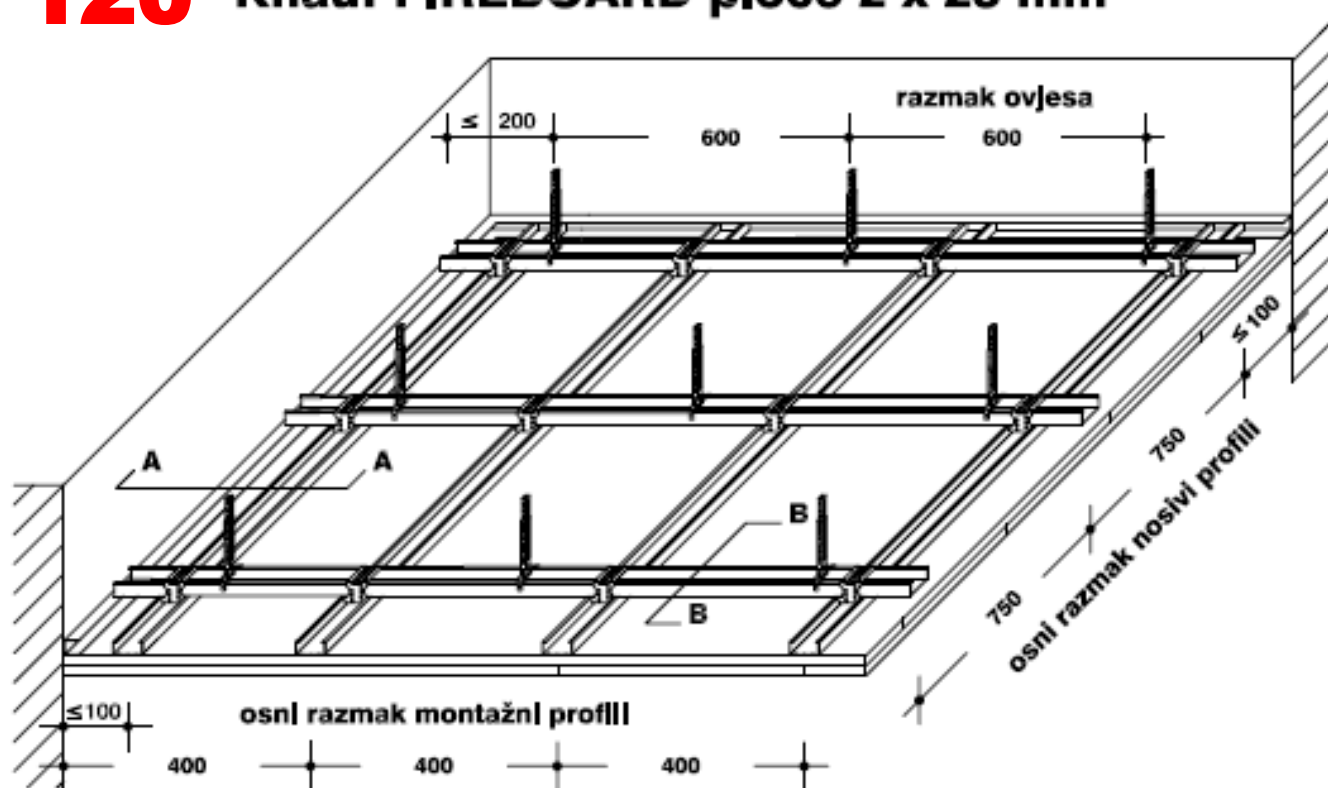

Protivpožarni i akustični spuštteni plafoni D12

D124 Knauf Cleano Akustik protupožarni strop

• Donja potkonstrukcija pričvršćena s kopčom za direktnu montažu

Apsorpcija zvuka
(vidi stranice 5, 14 i 15)

F30 • samo odozdo
(mineralna vuna vidi stranicu 22)

Štogurno na udarac lopčom
(vidi stranicu 27)

• Donja potkonstrukcija pričvršćena s direktnim ovisom

Protupožarna zaštita
+
Akustika

• Donja potkonstrukcija pričvršćena s direktnim ovisom

Apsorpcija zvuka
(vidi stranice 5, 14 i 15)

F30 • samo odozdo i odozgo
(mineralna vuna vidi stranicu 22)

Štogurno na udarac lopčom
(vidi stranicu 27)

• Donja potkonstrukcija pričvršćena s kopčom za direktnu montažu

Protupožarna zaštita
+
Akustika

Samonoseći spuštjeni plafoni D 131 / K 219

F30 do F90

Hodnici – sigurnosni evakuacioni putevi – obostrana zaštita od požara

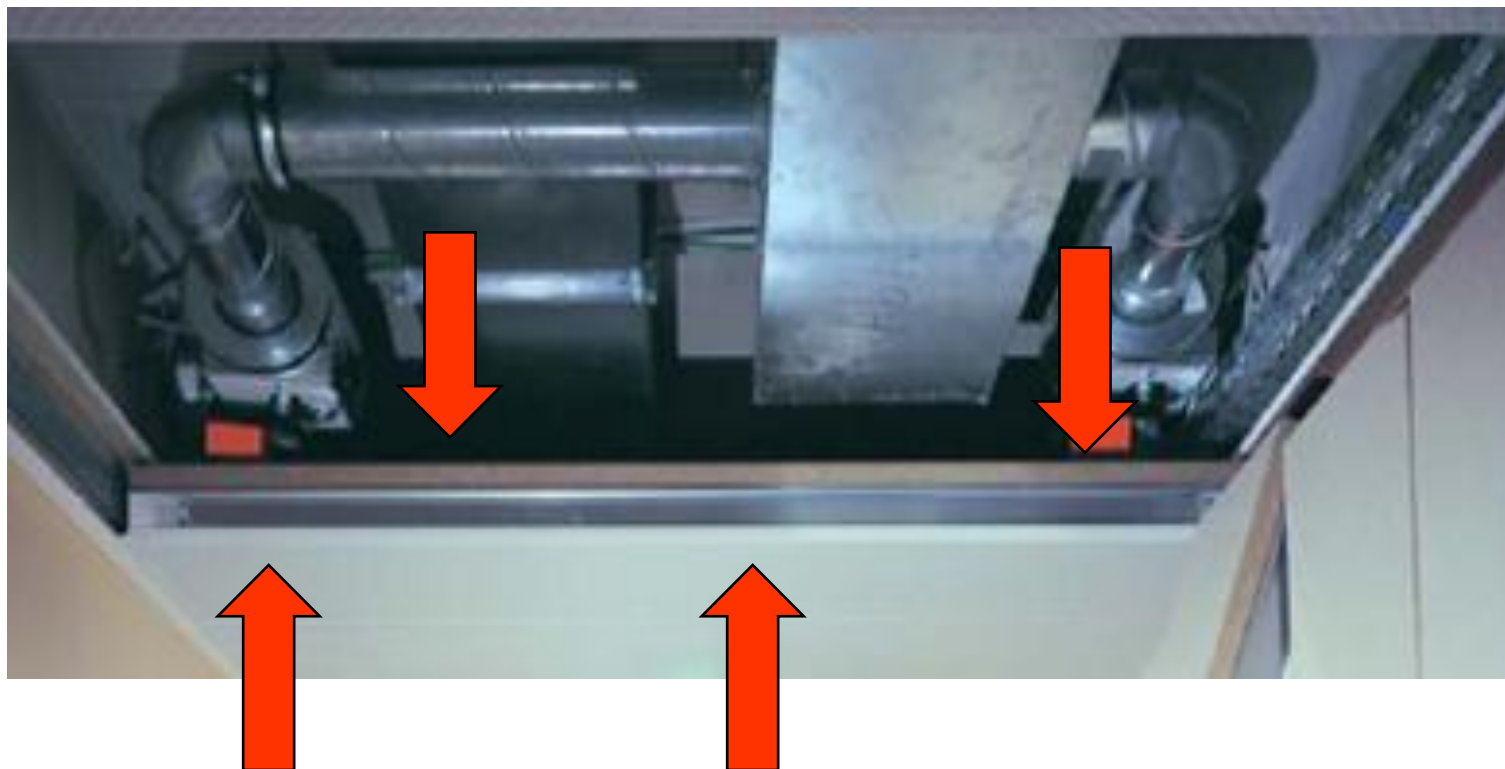

Protivpožarni plafoni od Fireboard ploča

Požarna zaštita odozdo za trapezaste limove / sistem K215

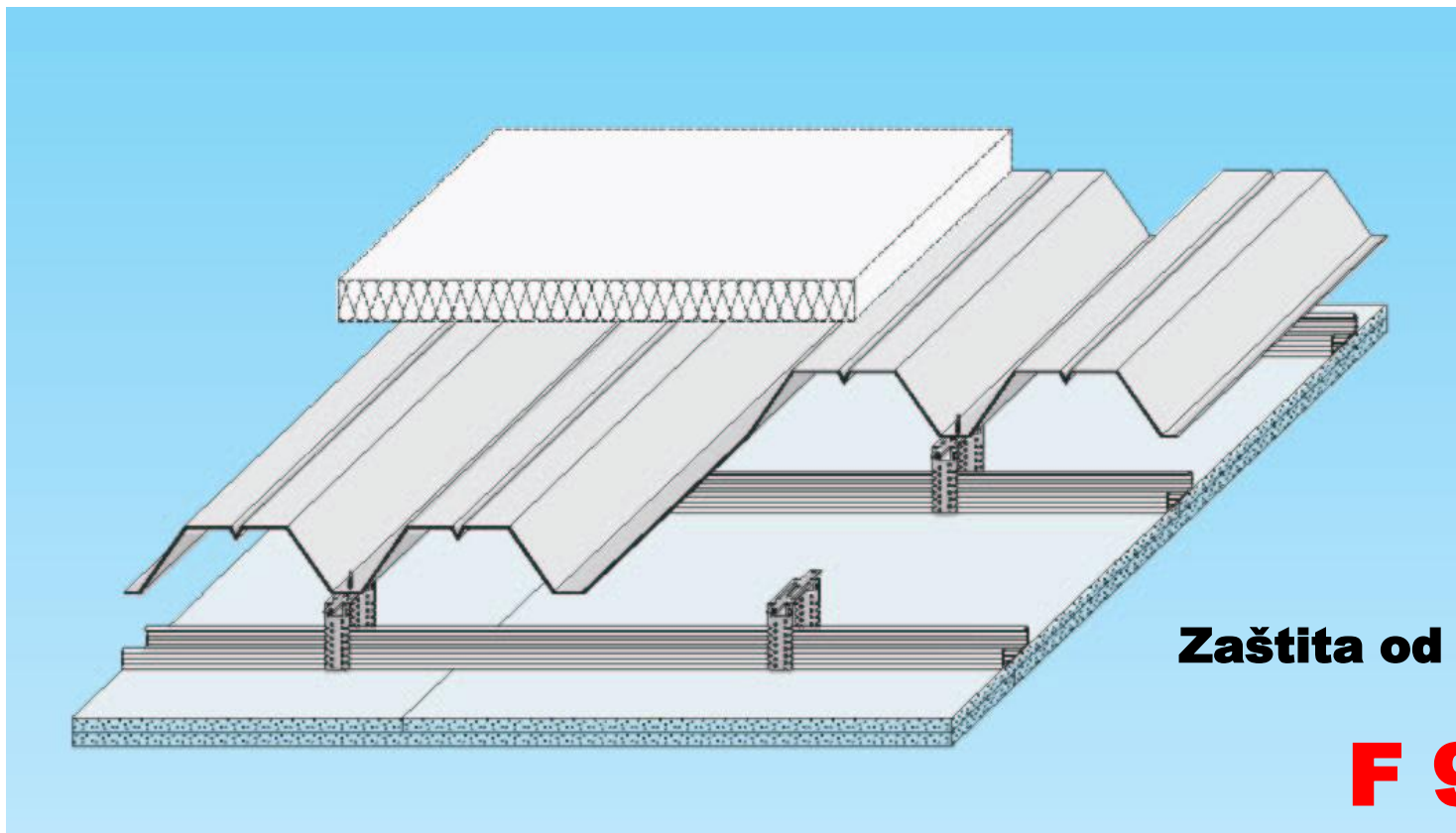

Zaštita od požara do

F 90

Obloga elektro i instalacionih kanala



Obostrana zaštita od požara do

F 120

Obloga ventilacionih kanala



**Zaštita od požara
do**

F 120

Oblaganje potkrovlja

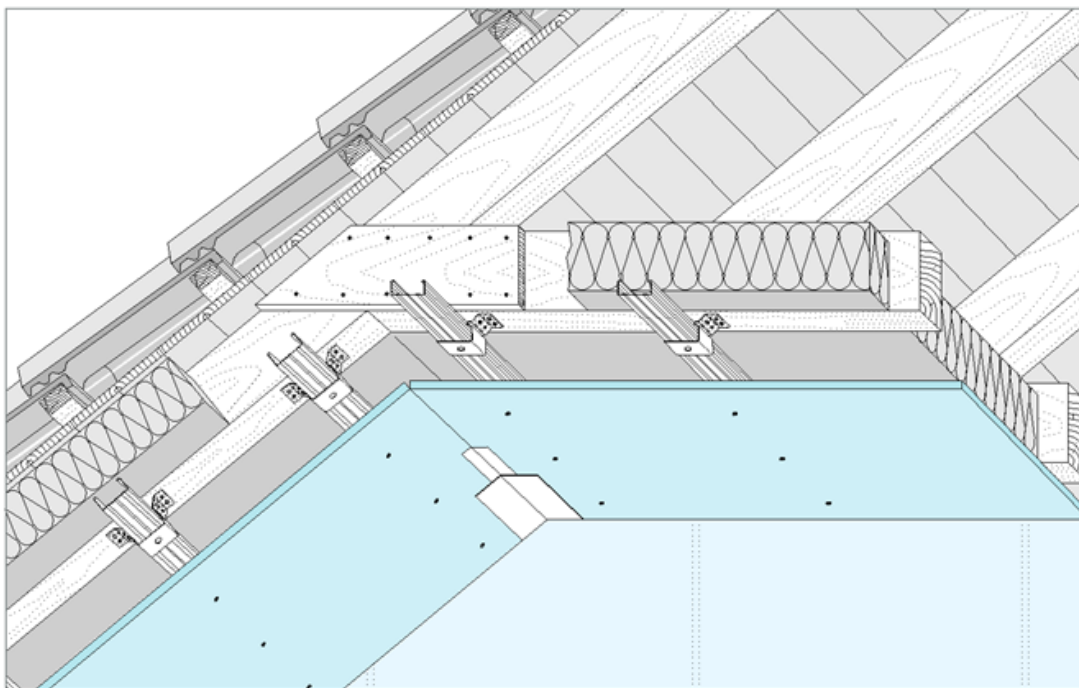

Zaštita od požara do

F 90